

Rocket

Designed by Casey York
Featuring the Sock Monkeys In Space collection by MY KT
Size: 53" x 60"











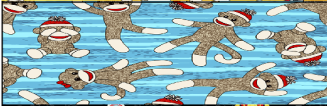

Check www.windhamfabrics.com Free Project section to see if there are any pattern updates before you start your quilt project

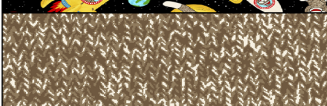

812 Jersey Ave ~ Jersey City, NJ 07310 ~ 201.659.0444 ~ FAX: 201.659.9719
www.windhamfabrics.com email: retail@windhamfabrics.com

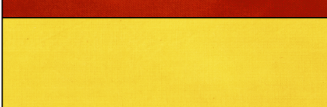
Rocket

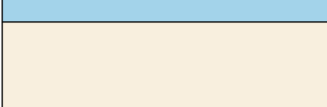
Page 2

	41173-3	¼ yd	Patchwork blocks
	41173-4	¼ yd	Patchwork blocks
	41170-X	¼ yd	Patchwork blocks
	41171-1	1 ½ yd	Background
	31641-6	1 yd	Borders
	41169-X	1 ¾ yd	Borders
	41172-2	1 1/4 yd	Appliqués & patchwork block & binding
	37098-16	1 yd	Rocket body & Monkey Appliqués
	37098-46	½ yd	Appliqués
	31338	¼ yd	Appliqués
	25029	¼ yd	Appliqués
	37098-1	¼ yd	Appliqués
	41169-X	3 ½ yd	Backing

Double-sided Light Fusible Web (15" wide) // 2 yards // appliques

Rocket

Page 3

Cutting instructions:

1. From the Black and White Text print (41171-1), cut a rectangle measuring 27.5" wide X 46.5" long for the central appliquéd panel. (**Note:** because this print is directional, take care to cut the rectangle so that the longer edges align with the selvages and the text is oriented in line with the shorter edges.)
2. From the Red and White Star fabric (31641-6), cut:
 - (4) strips measuring 4.5" X 23.5"
 - (2) strips measuring 4.5" X 35.5"
3. From the Multi-Colored fabric (41169-X), cut:
 - (2) strips measuring 3.5" X 54.5"
 - (2) strips measuring 3.5" X 41.5"
4. From the Rocket print (41170-X), Yellow Sock Monkey print (41173-3), and Blue Sock Monkey print (41173-4), cut (2) 6.5" X 6.5" squares each (for a total of 6 squares)
5. From the Brown Knit print (41172-2), cut (1) 6.5" X 6.5" square. Set aside the rest of the Brown Knit print for the appliqué.
6. From the Red Solid (37098-16 Cherry), cut:
 - (6) strips measuring 2.5" X 6.5"
 - (2) strips measuring 3.5" X 12.5"
 - (4) strips measuring 3.5" X 27.5"Set aside the rest of the Red Solid for the Rocket Body appliqué

Piece the patchwork strip:

1. Sew two red 3.5" X 27.5" strips together along the 3.5" end to form one long strip measuring 3.5" wide X 54.5" long. Repeat with the other two 3.5" X 27.5" red strips (now you should have (2) strips measuring 3.5" X 54.5".)
2. Following the Piecing Diagram, sew the 6.5" squares and 2.5" X 6.5" red strips together along the 6.5" sides, alternating print squares and red solid strips. (**Note:** all four prints are directional, so take care to orient squares in the correct directions, as noted in the diagram.)

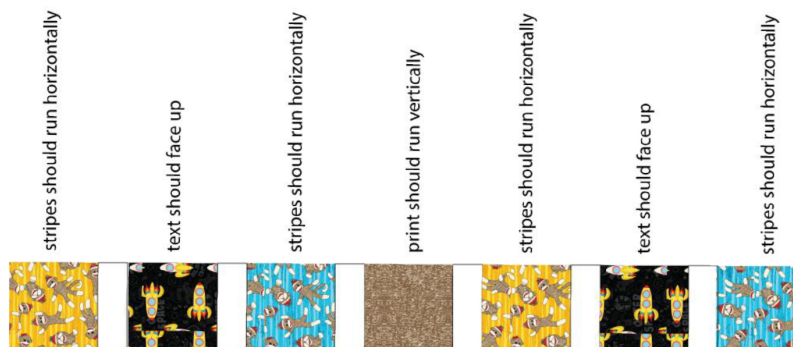

Rocket

Page 4

3. Stitch the 3.5" X 54.5" red strips to both long edges of the pieced strip resulting from step 2. Stitch the 3.5" X 12.5" strips to the top and bottom of the resulting piece.

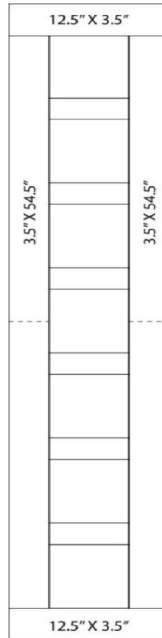

Piece the appliquéd panel:

1. Stitch one pair of Red and White Star 4.5" X 23.5" strips together along one 4.5" side to form a single long strip measuring 4.5" X 46.5;" repeat with the other pair of strips (now you should have (2) 4.5" X 46.5" strips).
2. Stitch one 4.5" X 46.5" Red and White Star strip to each 46.5" side of the Black and White rectangle. Stitch one 4.5" X 35.5" Red and White Star strip to the top and bottom of the resulting pieced panel. The resulting rectangle will measure 35.5" wide X 54.5" long.

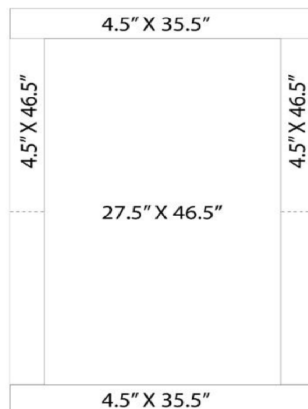

WINDHAM FABRICS

Rocket

Page 5

3. Stitch one 3.5" X 54.5" Multi-Colored strip to each long side of the pieced rectangle resulting from step 2 above. Stitch one 3.5" X 41.5" Multi-Colored strip to the top and bottom of the resulting panel.

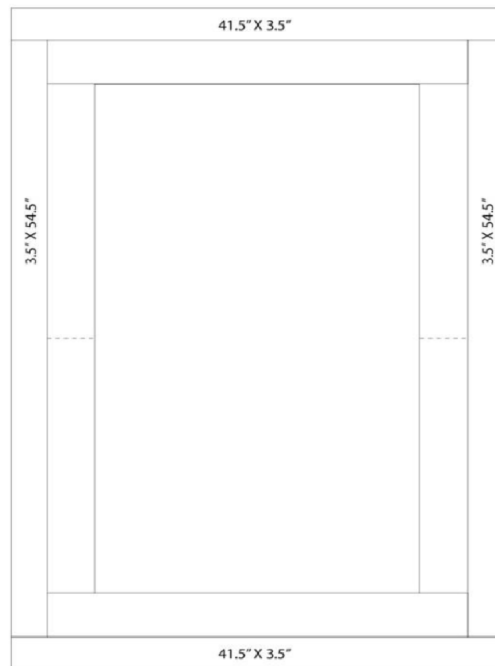

Make and stitch the appliqués:

1. Print the templates for the Rocket, Girl Monkey, and Boy Monkey; the Rocket Body template will need to be taped together along the dashed lines (this is indicated on the template). Templates have already been reversed for tracing onto fusible web.
2. Following the manufacturer's instructions, trace the templates onto the paper-backed fusible web. Copy the color recommendations onto each traced template.
3. Cut out the traced templates, leaving a 1/4" margin around the edges.
4. Following the manufacturer's instructions, fuse the traced templates to the **wrong** side of each appliqué fabric.
5. Using very sharp scissors to minimize fraying, cut out the fabric shapes along the traced lines.

Rocket

Page 6

6. Following the **Placement Diagram**, place the appliqués on the central background rectangle. Remove the paper backing from the fusible web and pin each appliqué in place as you go. Appliqué pieces will overlap one another.

- (a) Place the Rocket Body first.
- (b) Then place the two light blue Windows, which will overlap the edges of the cut-out circles in the Rocket Body appliqué along the outer edges.
- (c) Finally, place the two yellow Window Rim appliqués so that they overlap the outer edges of the Window appliqués.
- (d) The Nose Cone and Rocket Base will overlap the Rocket Body, and the three Rocket Fins will overlap the Rocket Body and the Rocket Base.
- (e) The Girl and Boy Monkey appliqués should be centered on the light blue Windows.

7. When you are satisfied with your layout, use an iron to permanently fuse the fabric shapes to the background, again following the manufacturer's instructions (remember to remove pins before fusing!)

8. Stitch around each shape to secure to background. A zig-zag or machine blanket stitch can be used, using matching thread or invisible thread. A straight stitch can also be used, although this will result in more fraying of the appliqué fabrics along their edges.

Placement Diagram:

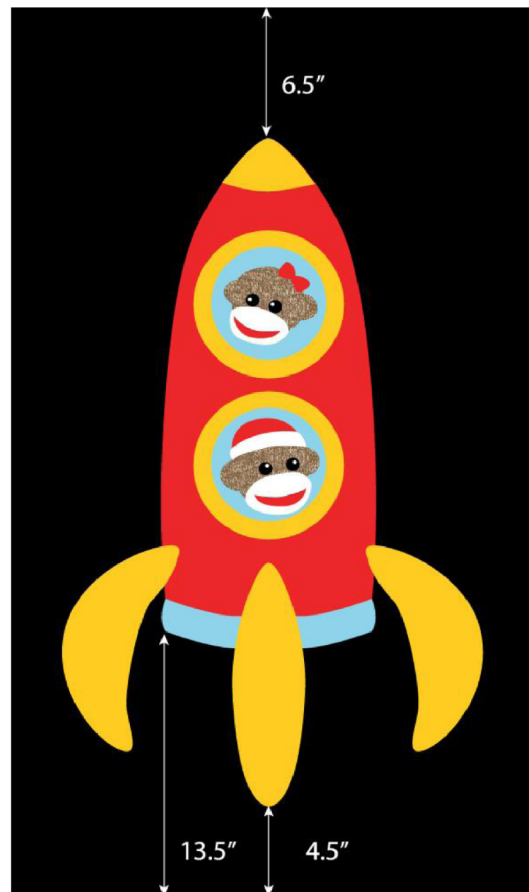

Rocket

Page 7

Finish the quilt

1. Stitch the patchwork strip to the appliquéd panel along the long right side.

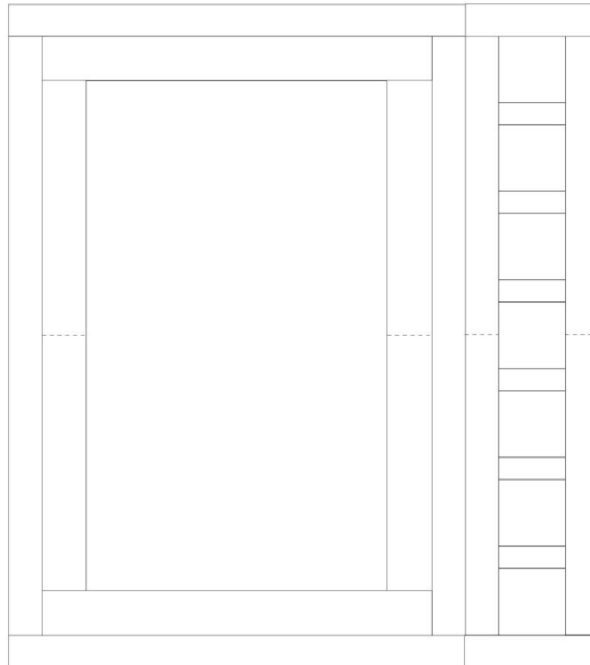

2. Layer, baste, and quilt as desired. Bind using your favorite method.

Be sure to visit www.windhamfabrics.com to see the complete collection
and to download other Free Projects

Template Printing Instructions

- Print using the latest version of Adobe Reader (available for free at www.adobe.com/products/reader.html).
Do Not print from your browser, as this will not give you the full range of scaling options.
- Print full size: in print dialog box, set printer options to "**Do not scale**" or "**Actual Size.**"
- Refer to the grey one inch box to ensure printing at correct size
- Some templates will need to be taped together; use the dashed lines to align the sections of each template
- Templates are already reversed for tracing onto fusible web
- Templates do not include seam allowance

1" X 1"

Monkey Eyes
Cut 4 from black
(37098-1 Vine Black)

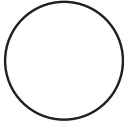

Monkey Eye Highlights
Cut 4 from ivory
(25029)



Boy Monkey Hat
Cut 1 from red
(37098-16 Cherry)

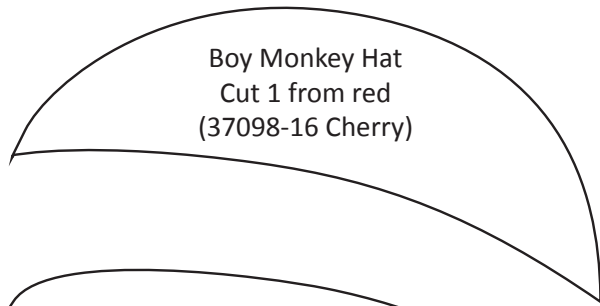

Boy Monkey Hat Band
Cut 1 from ivory
(25029)

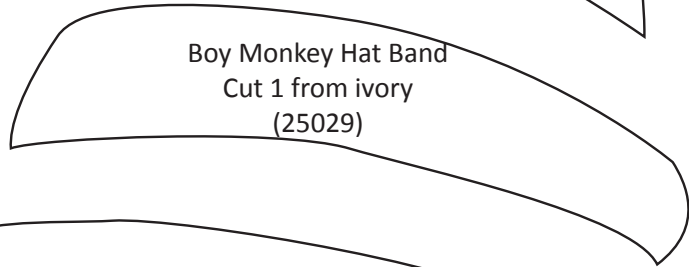

Boy Monkey Face
Cut 1 from brown
(41172-2)

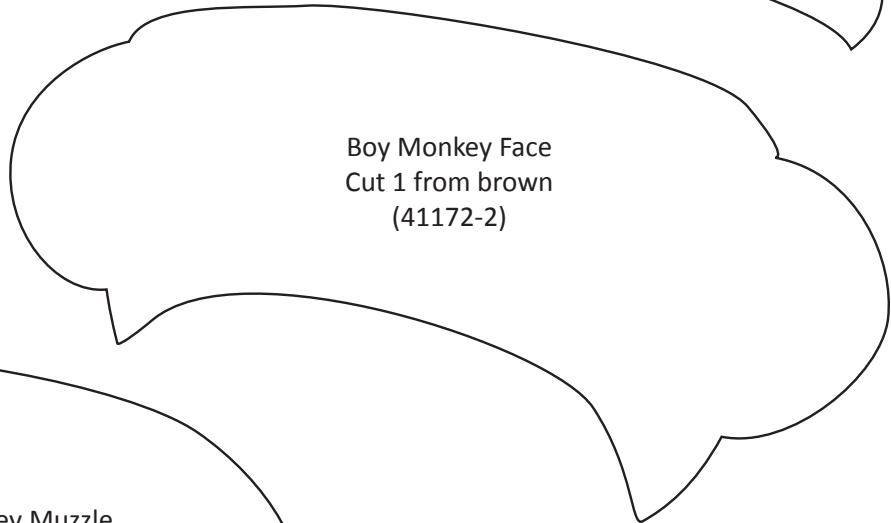

Boy Monkey Muzzle
Cut 1 from ivory
(25029)

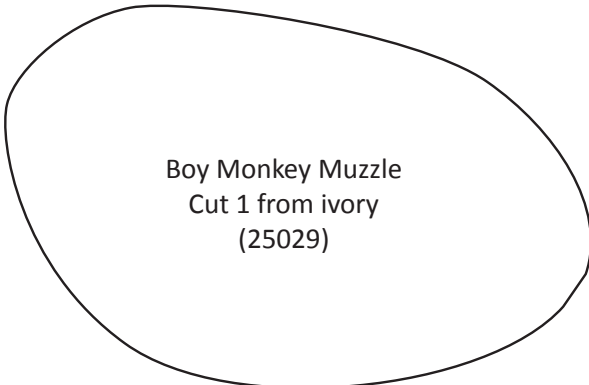

Boy Monkey Smile
Cut 1 from red
(37098-16 Cherry)

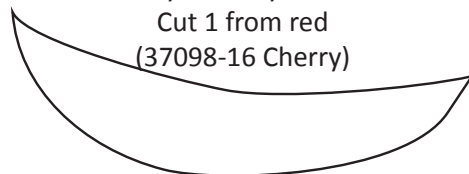

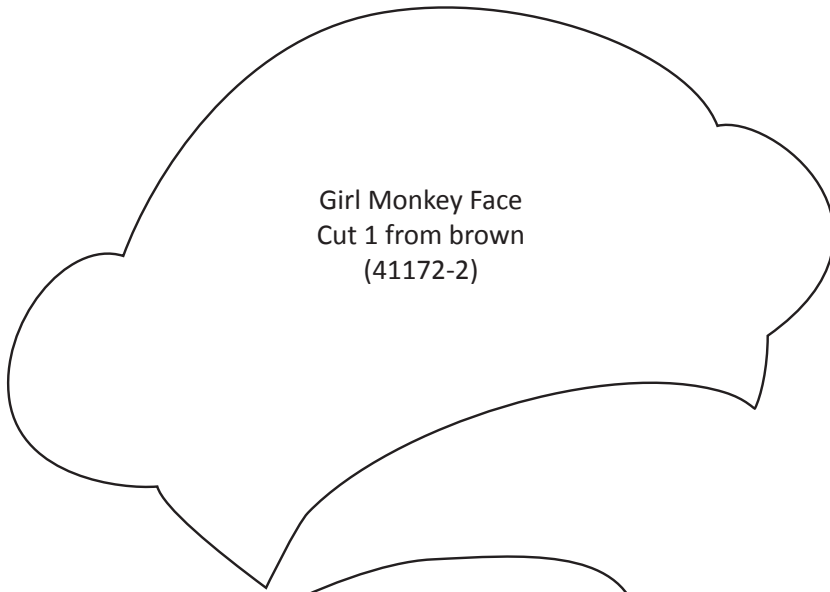

Girl Monkey Face
Cut 1 from brown
(41172-2)

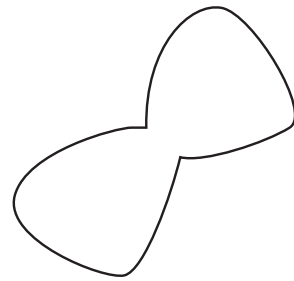

Girl Monkey Bow
Cut 1 from red
(37098-16 Cherry)



Girl Monkey Muzzle
Cut 1 from ivory
(25029)

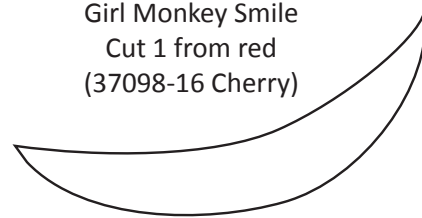

Girl Monkey Smile
Cut 1 from red
(37098-16 Cherry)

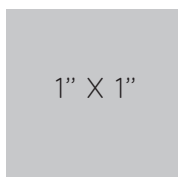

1" X 1"

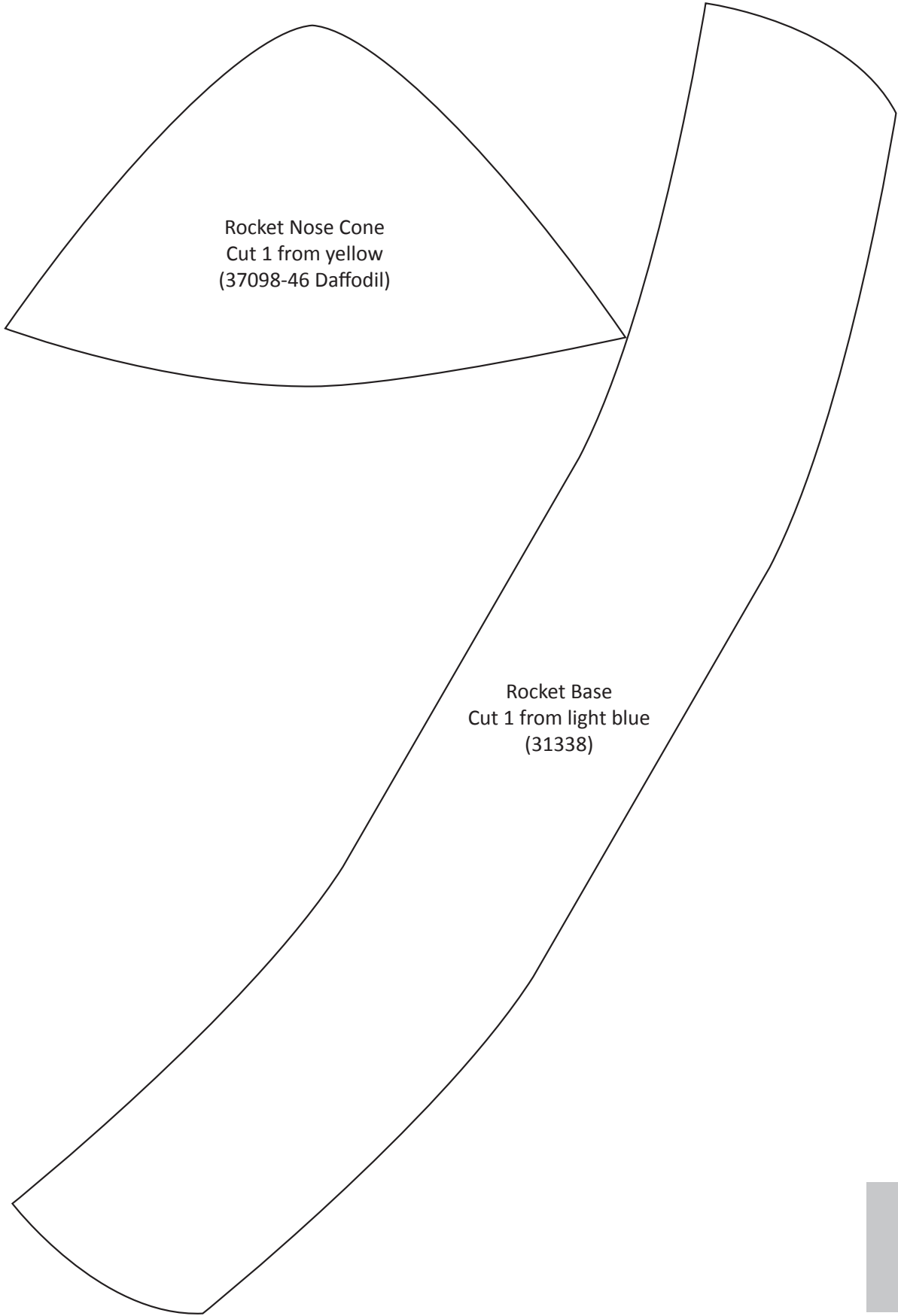

Rocket Nose Cone
Cut 1 from yellow
(37098-46 Daffodil)

Rocket Base
Cut 1 from light blue
(31338)

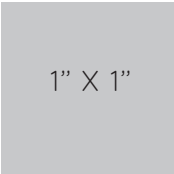

1" X 1"

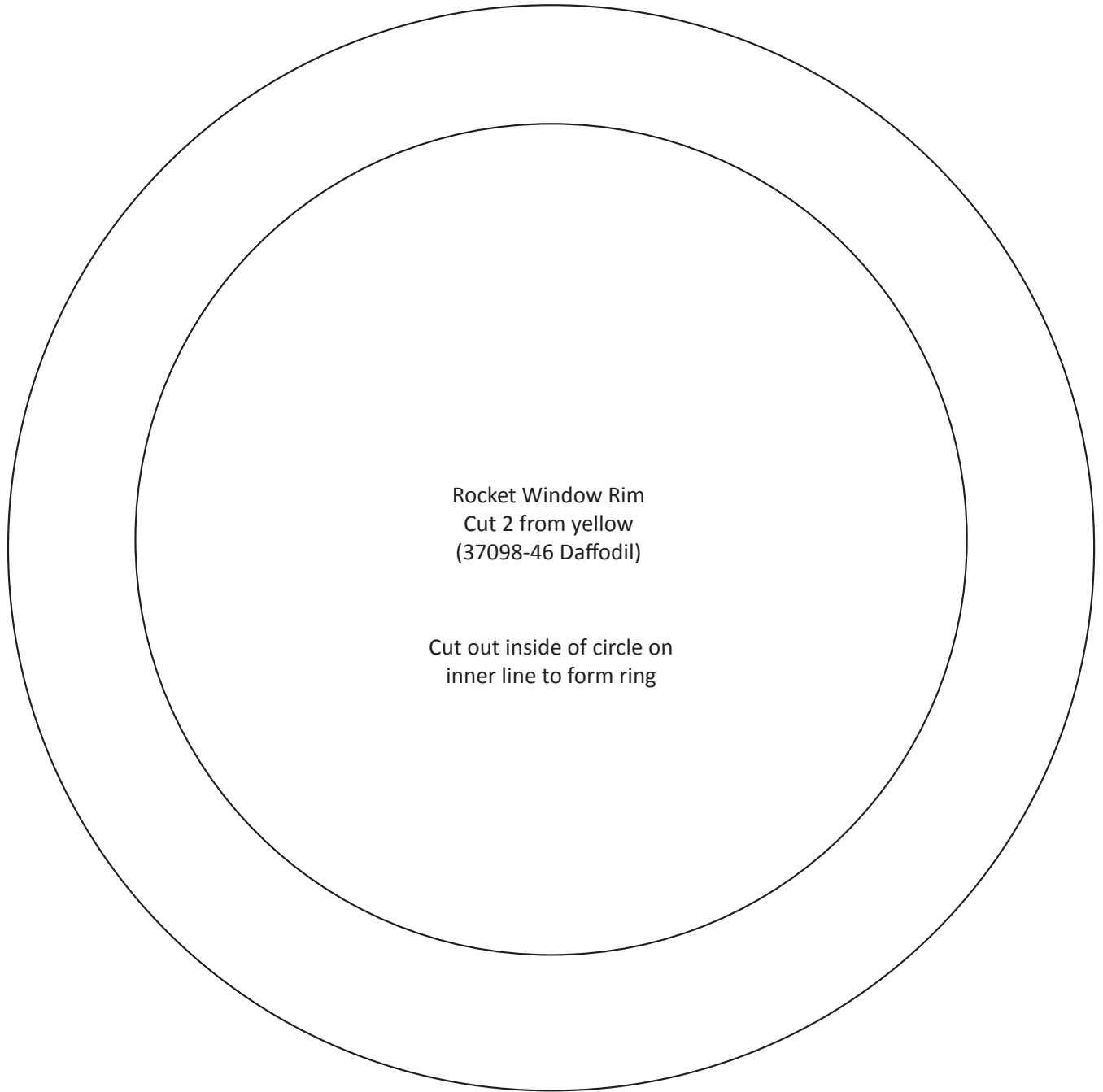

Rocket Window Rim
Cut 2 from yellow
(37098-46 Daffodil)

Cut out inside of circle on
inner line to form ring

1" X 1"

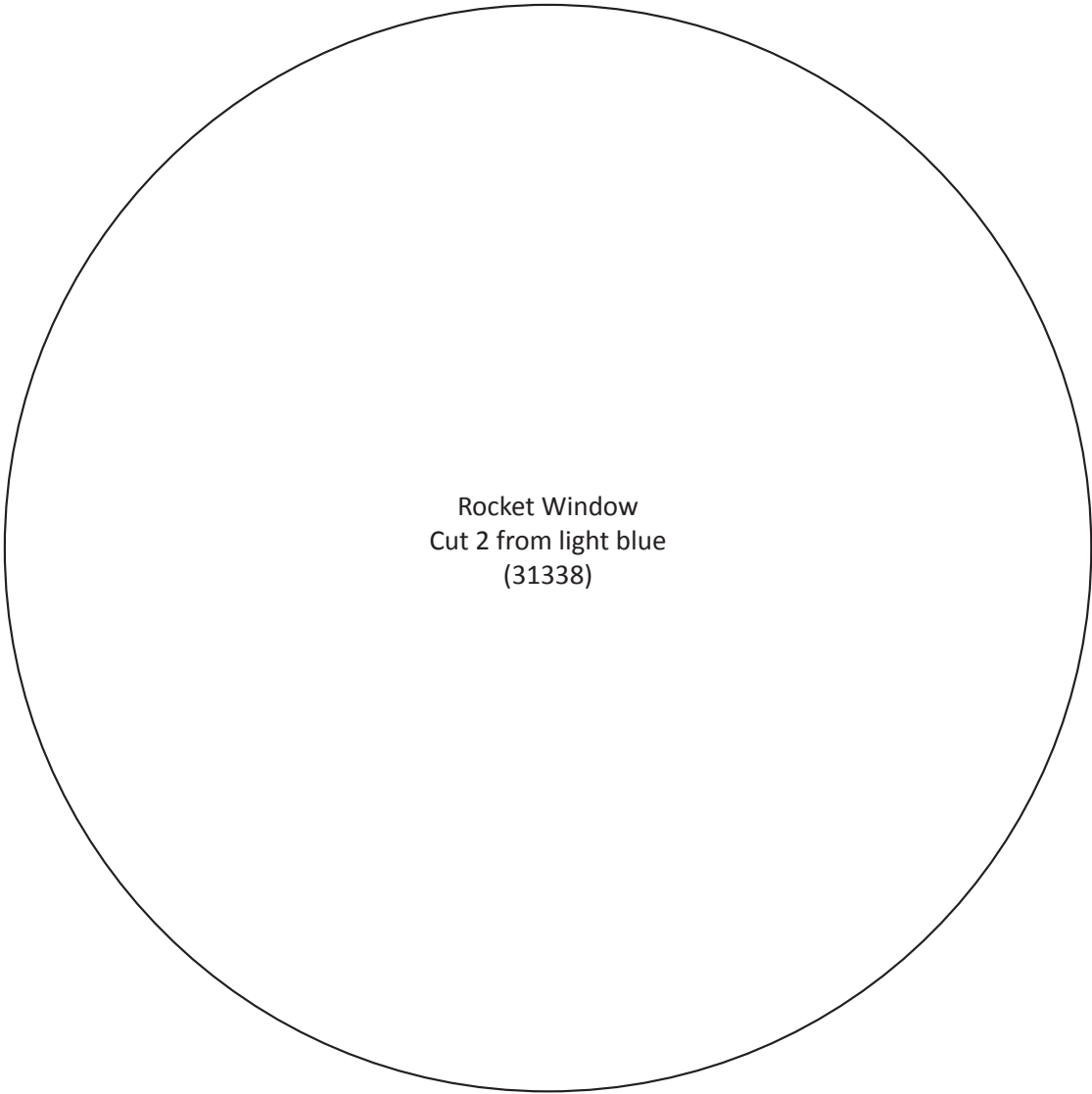

Rocket Window
Cut 2 from light blue
(31338)

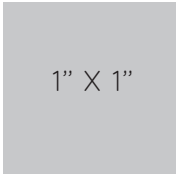

1" X 1"

1" X 1"

Rocket Body 1/6

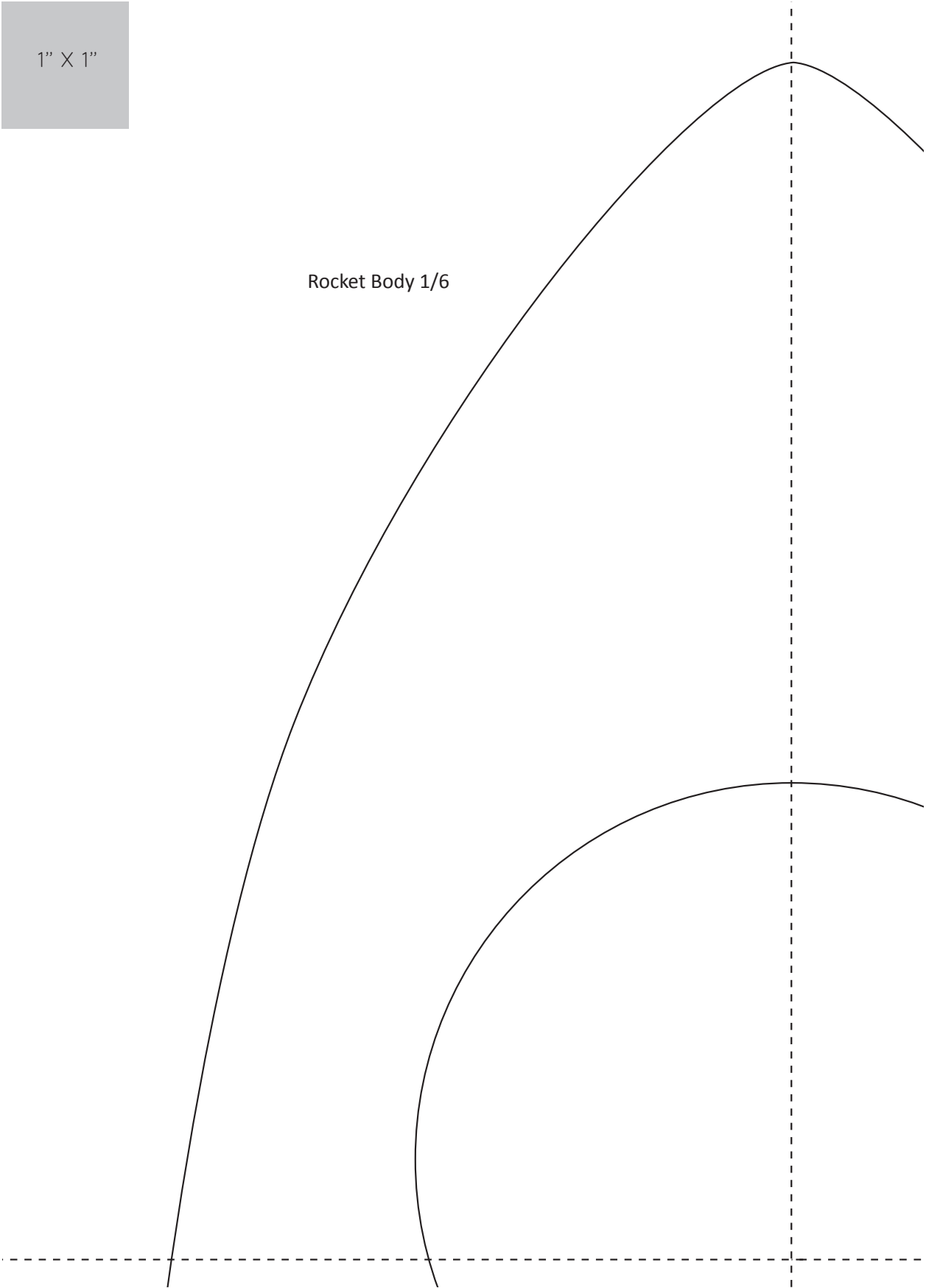

1" X 1"

Rocket Body 2/6

Rocket Body
Cut 1 from red
(37098-16 Cherry)

Cut out inside of circle on line

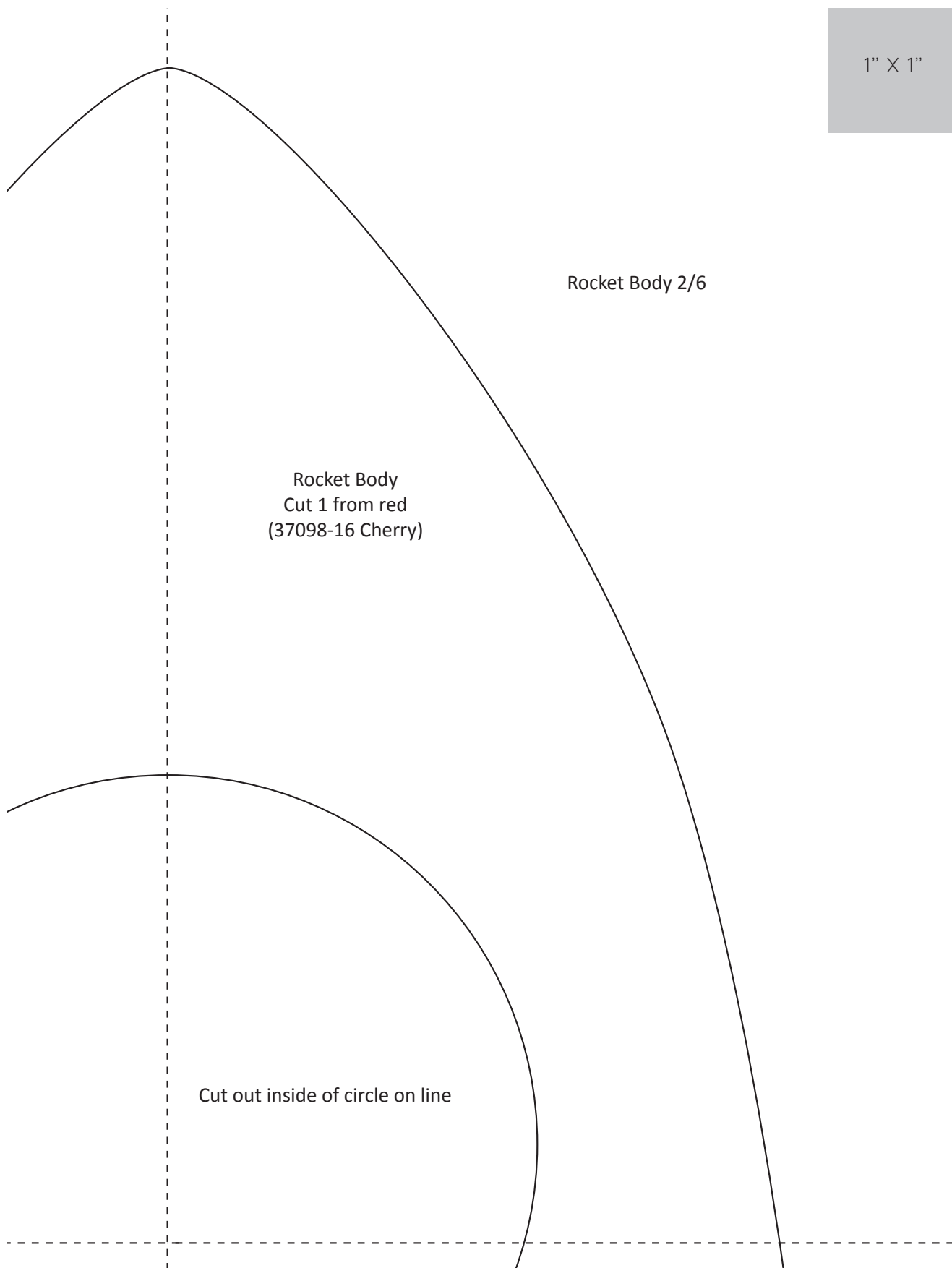

1" X 1"

Rocket Body 3/6

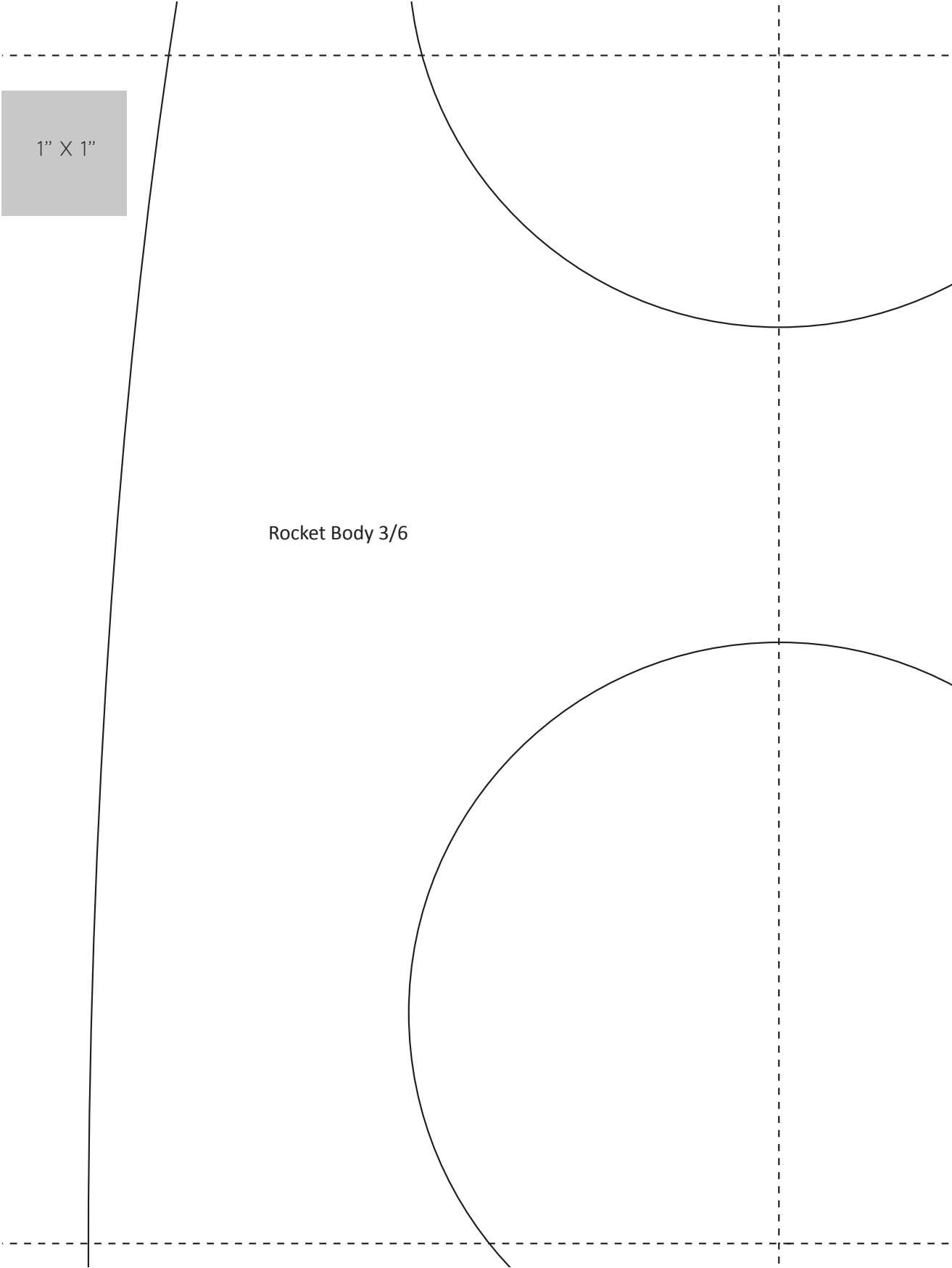

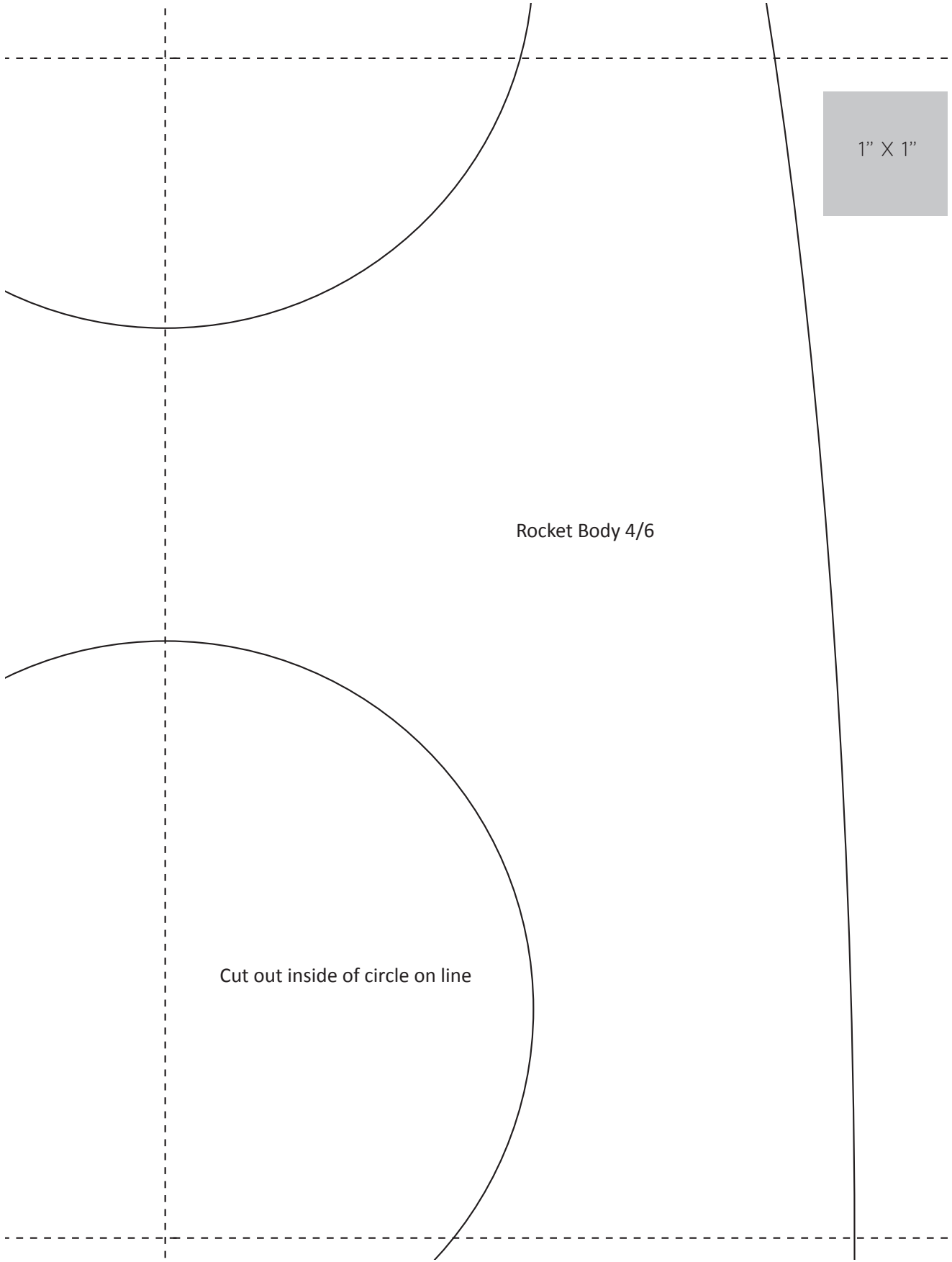

Rocket Body 4/6

Cut out inside of circle on line

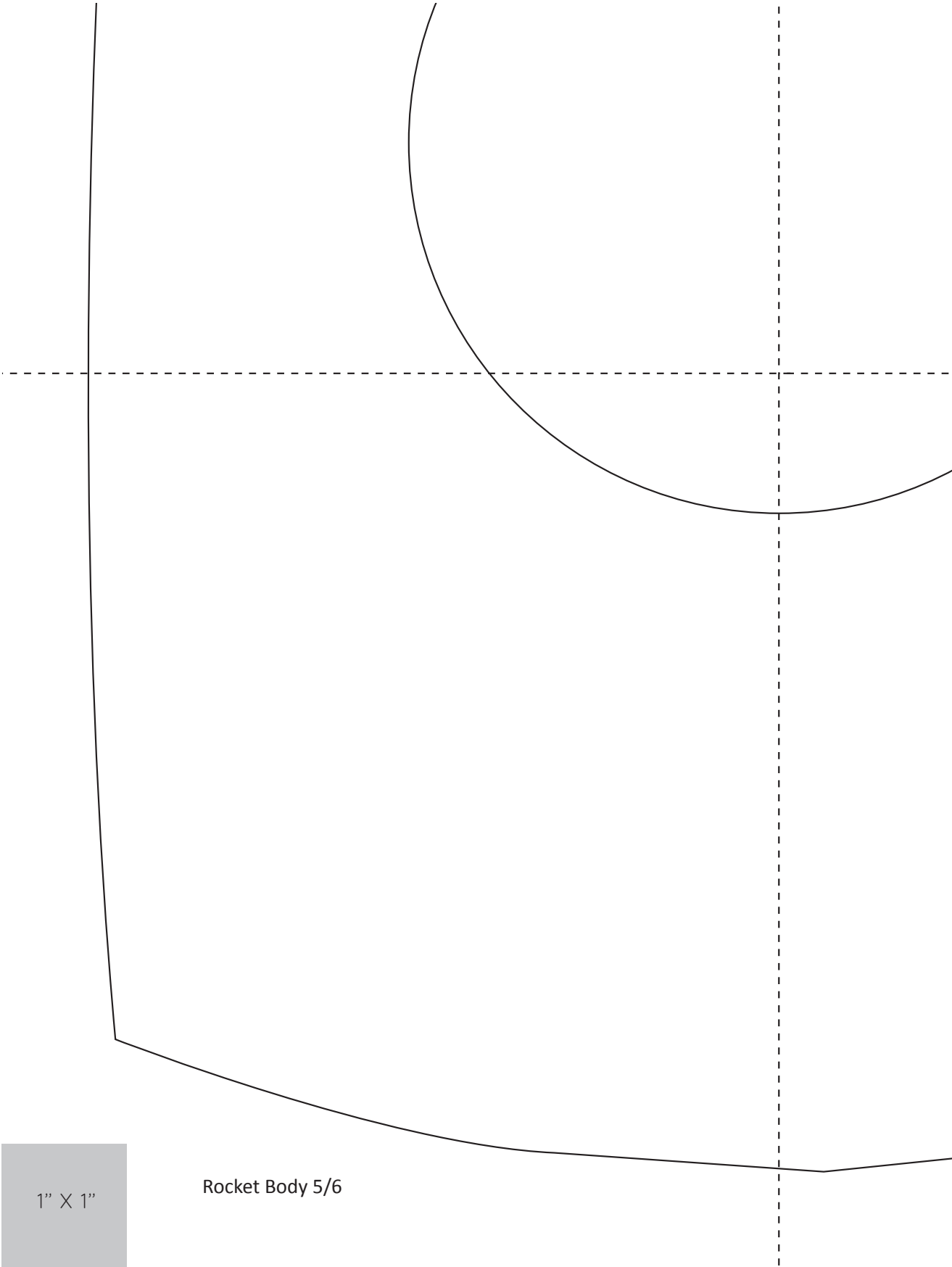

1" X 1"

Rocket Body 5/6

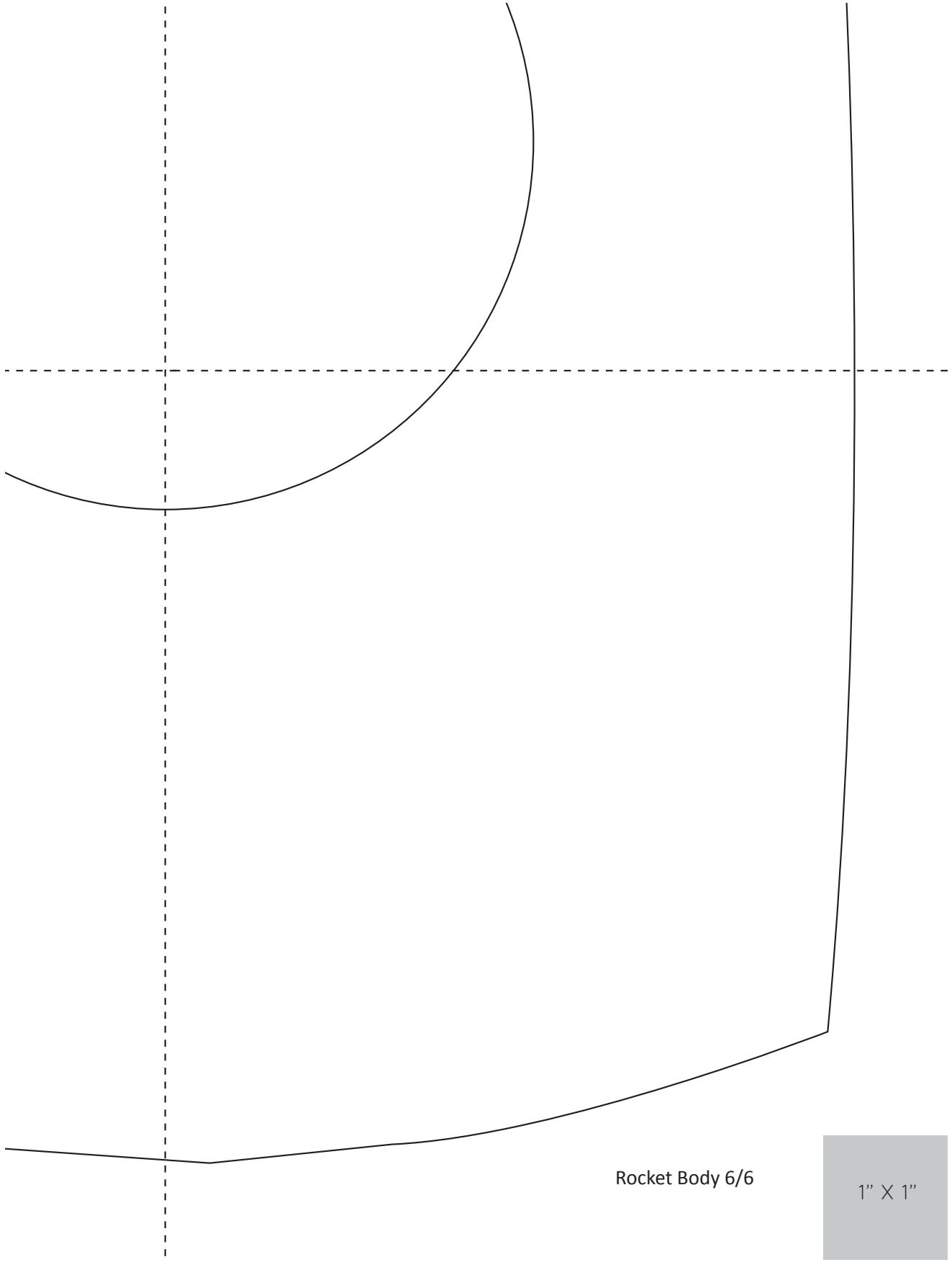

Rocket Body 6/6

1" X 1"

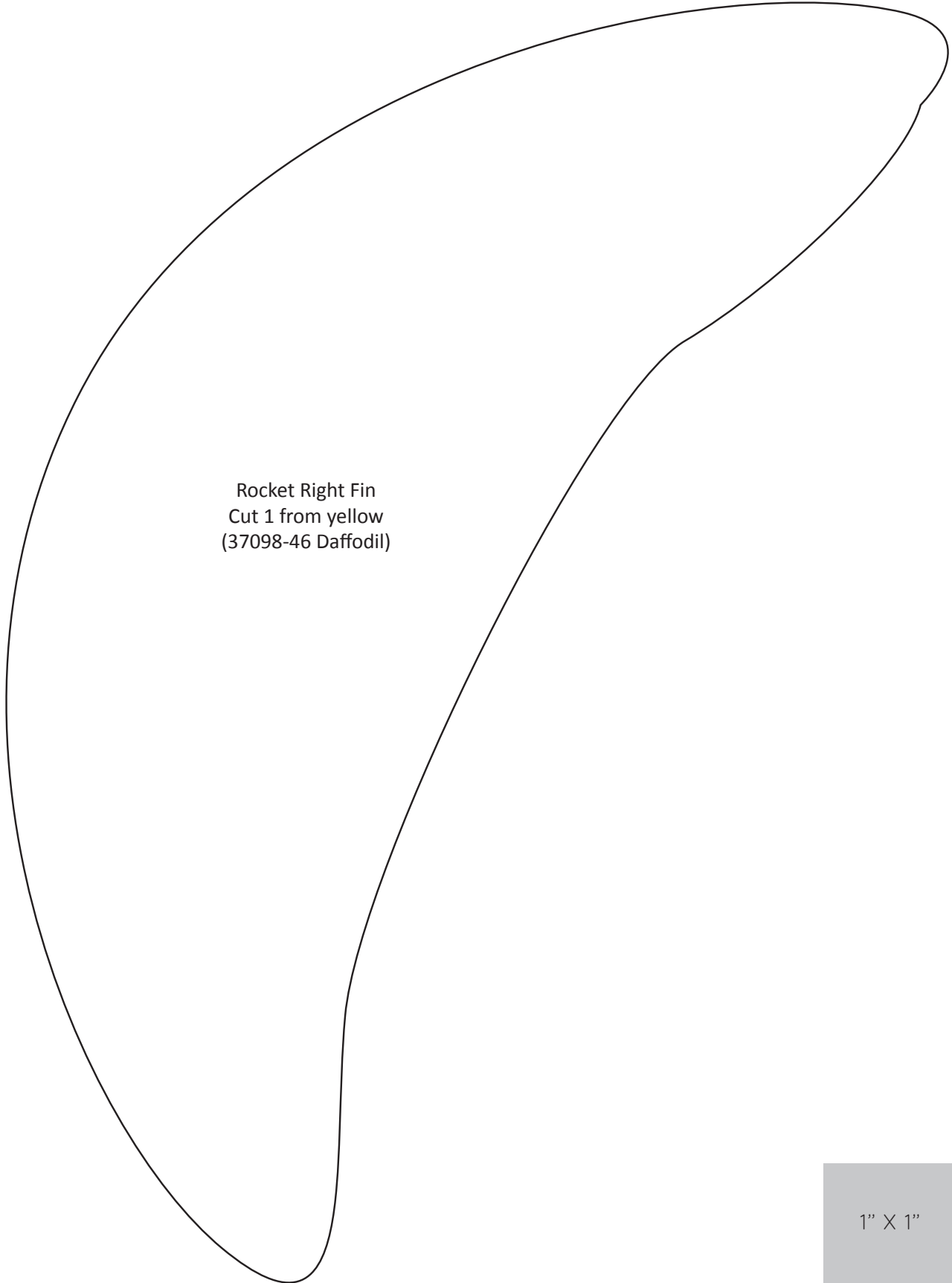

Rocket Right Fin
Cut 1 from yellow
(37098-46 Daffodil)



1" X 1"

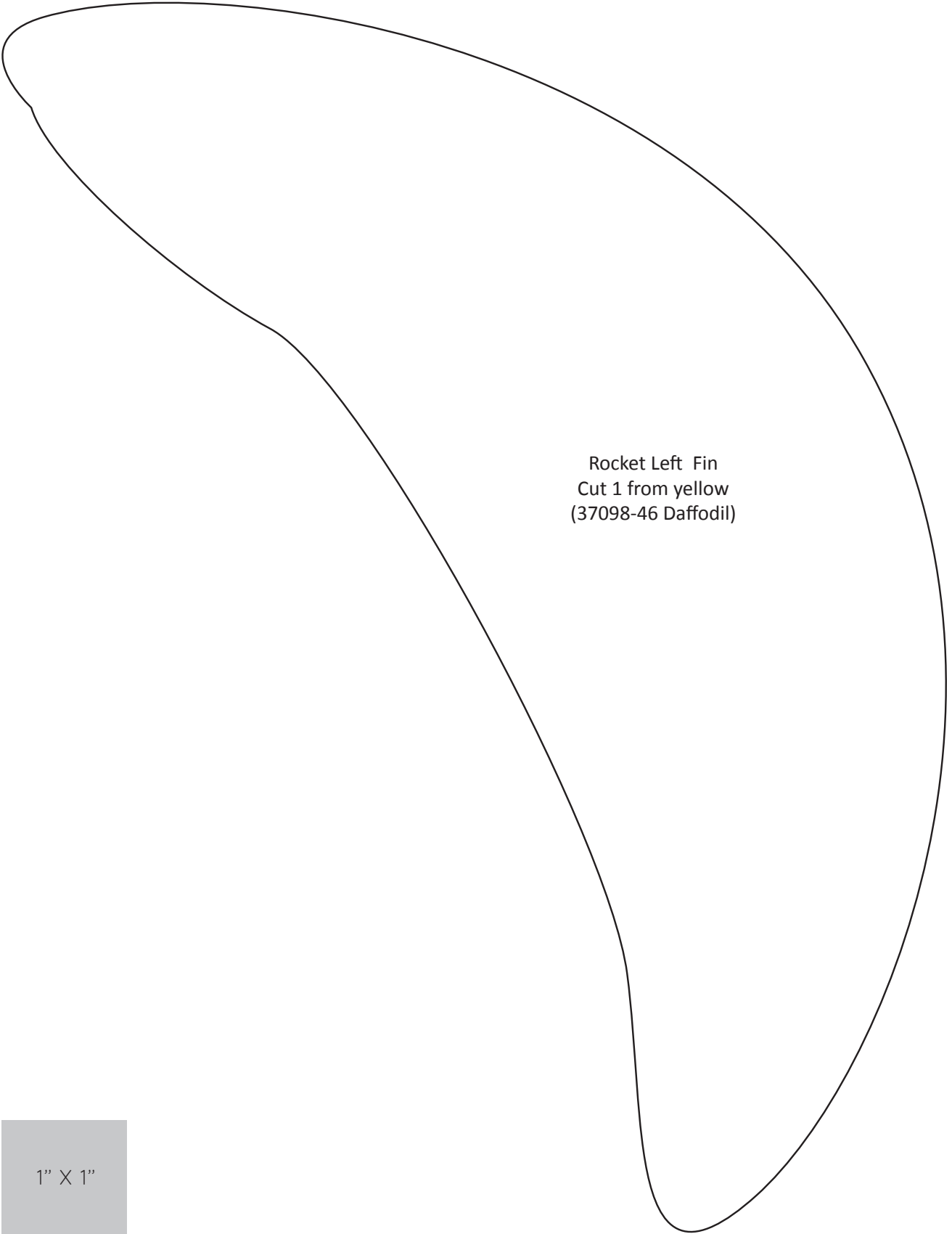

Rocket Left Fin
Cut 1 from yellow
(37098-46 Daffodil)

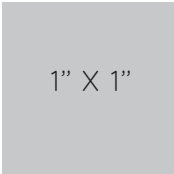

1" X 1"

1" X 1"

Rocket Center Fin
Cut 1 from yellow
(37098-46 Daffodil)